

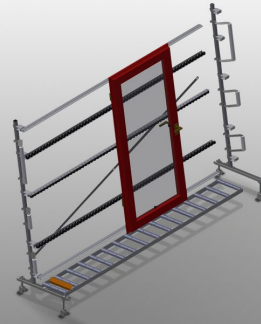

VR3003

Vertical roller conveyors



Vertical roller conveyor for transportation and storage of window elements

- Stable steel construction
- Expandable using modular system design
- Vertical roller conveyor for smooth transportation and storage of window elements
- Easy handling of window elements
- Every roller conveyor unit is 3,000 mm long
- Roller conveyor divided into three parts
- Plastic slide bars top and bottom
- Three mini-roller conveyors with rubber rollers, diameter 50 mm
- Basic unit without end rack

Options

- End rack for VR 2003/3003/4003
- End stop for VR
- Lead-in roller for VR
- Profile protectors for support rollers (Alum.)



Vertical roller conveyor VR 3003

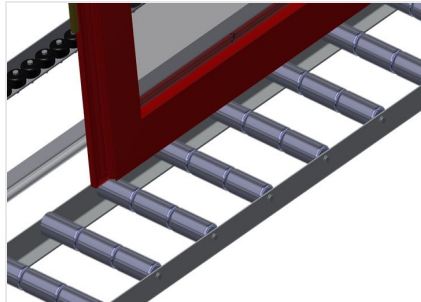

Support rollers

Rollers throughout, Roller conveyor divided into three parts, 3x 120 mm. Roller conveyor units, 2,000 mm, 3,000 mm and 4,000 mm long

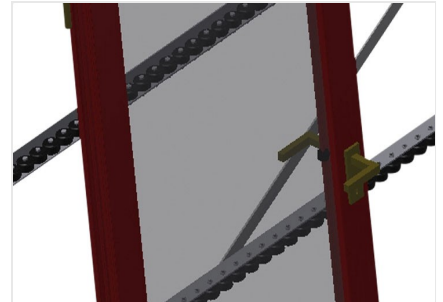

Mini-roller conveyor

Three mini-roller conveyors with rubber rollers, diameter 50 mm

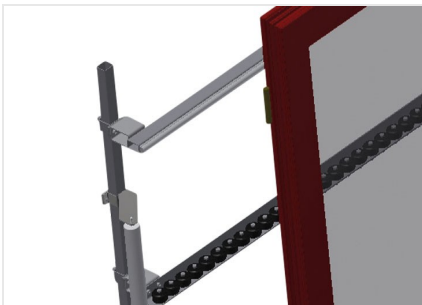

Back support

Rear back support with plastic slide bars, top and bottom

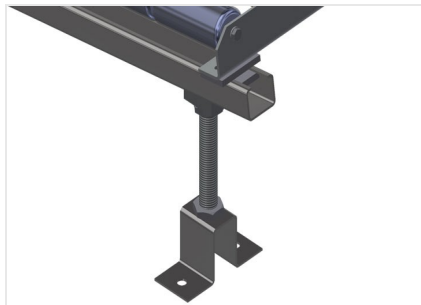

Roller conveyor height adjustment

Roller conveyor height adjustment

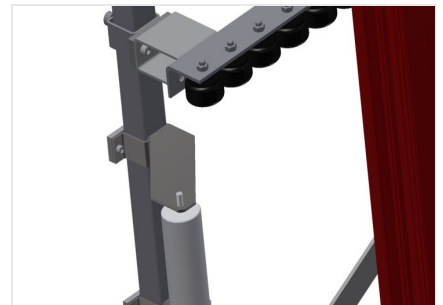

Mini-roller conveyor height adjustment

Mini-roller conveyor height is adjustable





End rack

End rack is mandatory at end of line

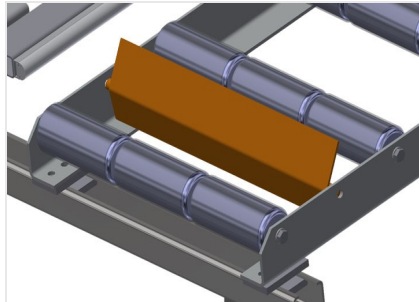

End stop

End stop Rb = 3x 120 mm



Lead-in rollers

Protective rollers for beginning or end of roller conveyor L = 500 mm (pair) L = 250 mm (pair)

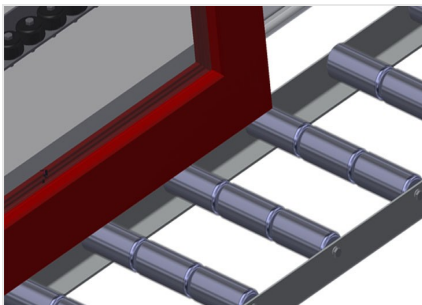

Profile protectors

Profile protectors for support rollers 3x 120 mm (Alum./33 x and Alum./48 x). Support rollers covered with protective tubing

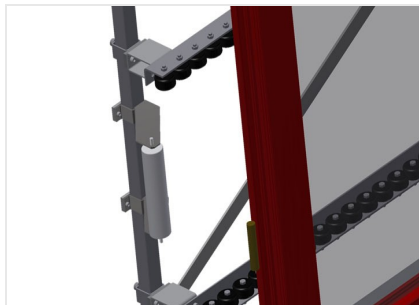

Additional mini-roller conveyors

Additional mini-roller conveyors with rubber rollers top/bottom





VR 3003 / VERTICAL ROLLER CONVEYORS

- Length 3,000 mm
- Width 900 mm
- Height 2,400 mm
- Support rollers divided into three parts 3 x 120 mm
- Unit height 2,100 mm
- Load 200 kg
- Weight 120 kg