

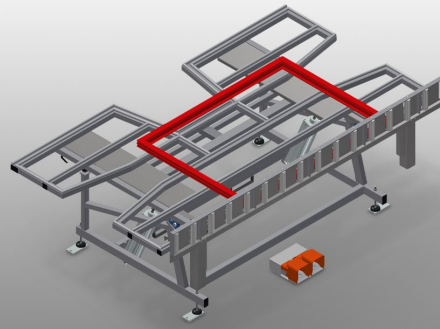

KT3000

Tilting tables



Assembly table for vertical and horizontal assembly

- Stable steel construction
- Important when switching from vertical to horizontal transportation and vice versa
- Ideal for vertical and horizontal assembly
- Pneumatic tilting
- Table supporting surface with plastic slide bars
- Roller support can be lowered pneumatically
- 4-fold compressed air supply

Options

- Also available with brush strips on request
- Also available with felt strips on request (for wooden profiles)
- Also available with rubber strips on request (for aluminium profiles)
- Pull-out table supporting surface at top for KT/KTH 3000
- Profile protectors for support rollers
- Mobility unit for KT/KTH/MS/VE
- Rail, 2.0 m

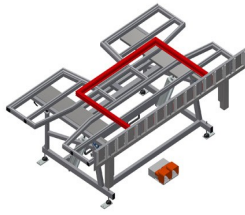

Tilting table KT 3000

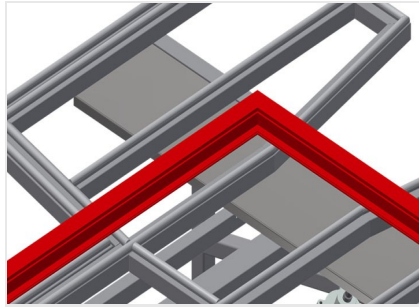

Supporting surfaces

Supporting surfaces with plastic slide bars

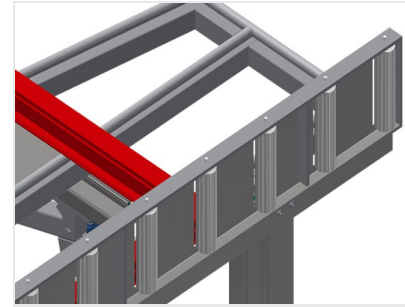

Roller support

Roller conveyor can be lowered pneumatically to allow unhindered working in horizontal position; in vertical position, trouble-free onward transport is possible

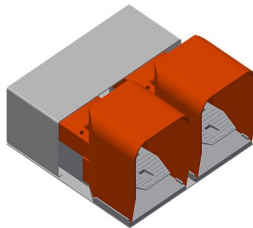

Foot switch

Control via foot valve, Pneumatic horizontal/vertical tilting

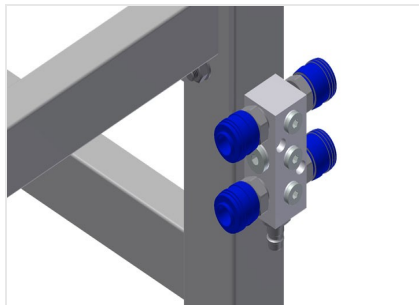

4-fold compressed air connection

4-fold compressed air connection for connecting compressed-air tools

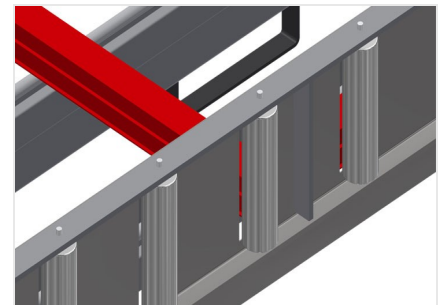

Profile protectors for support rollers

Profile protectors for support rollers 200 mm (Alum./16 x and Alum./21 x). Roller conveyor with protective tubing over the rollers to protect the window element during infeed and outfeed



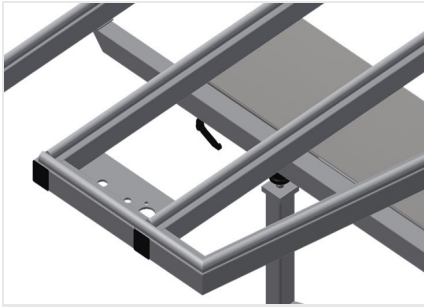

Pull-out profile support

Pull-out table support at top for KT/KTH 3000 and KT/KTH 4000. The table support can be pulled out 500 mm at the top for high frames



Brush strip

Supporting surfaces with brush strip



Felt strip

Supporting surfaces with felt profile strip

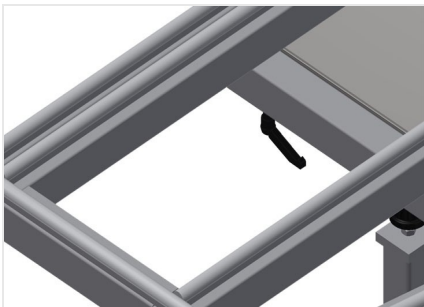

Rubber strips

Supporting surfaces with rubber-knob profile

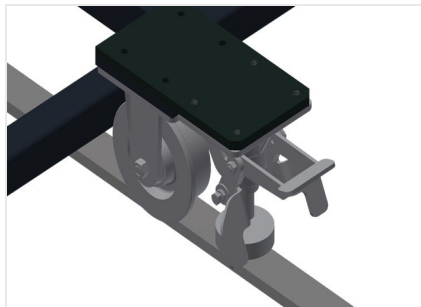

Mobility unit

Mobility unit for KT/KTH/MS/VE. Mobility unit with flanged rollers and fixing brake



Rails

Rails, 2.0 m, left and right





KT 3000 / TILTING TABLES

- Length 3,000 mm
- Width 1,820 mm
- Vertical height 1,900 mm
- Roller conveyor width 200 mm
- Weight 300 kg
- Load 200 kg
- Compressed air supply 7 bar
- Air consumption approx. 35 l/min.