

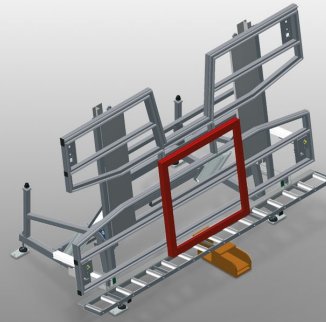

### **KT4000**

#### Tilting tables



Assembly table for vertical and horizontal assembly

- Stable steel construction
- Important when switching from vertical to horizontal transportation and vice versa
- Ideal for vertical and horizontal assembly
- Pneumatic tilting
- Table supporting surface with plastic slide bars
- Roller support can be lowered pneumatically
- 4-fold compressed air supply

#### **Options**

- Also available with brush strips on request
- Also available with felt strips on request (for wooden profiles)
- Also available with rubber strips on request (for aluminium profiles)
- Pull-out table supporting surface at top for KT/KTH 4000
- Profile protectors for support rollers
- Mobility unit for KT/KTH/MS/VE
- Rail, 2.0 m

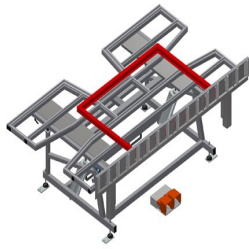

### Tilting table KT 4000

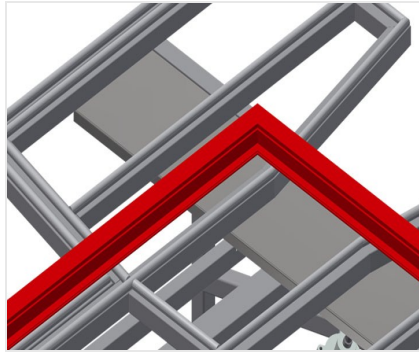

### Supporting surfaces

Supporting surfaces with plastic slide bars

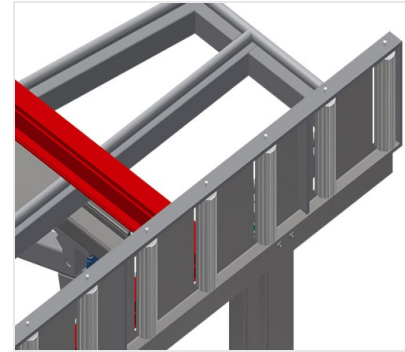

### Roller support

Roller conveyor can be lowered pneumatically to allow unhindered working in horizontal position; in vertical position, trouble-free onward transport is possible

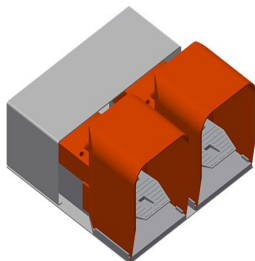

### Foot switch

Control via foot valve, Pneumatic horizontal/vertical tilting

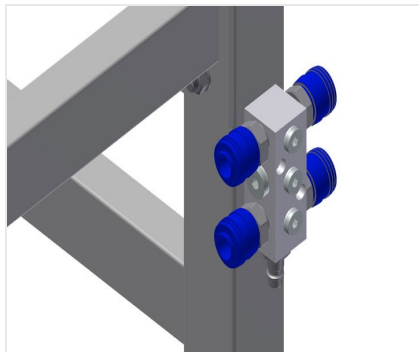

### 4-fold compressed air connection

4-fold compressed air connection for connecting compressed-air tools

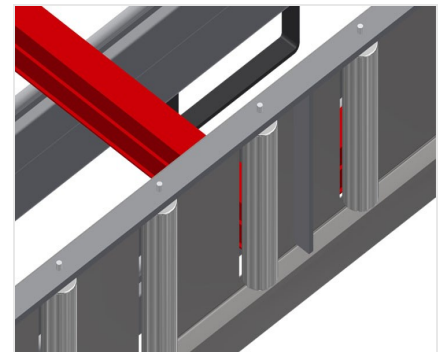

### Profile protectors for support rollers

Profile protectors for support rollers 200 mm (Alum./16 x and Alum./21 x). Roller conveyor with protective tubing over the rollers to protect the window element during infeed and outfeed



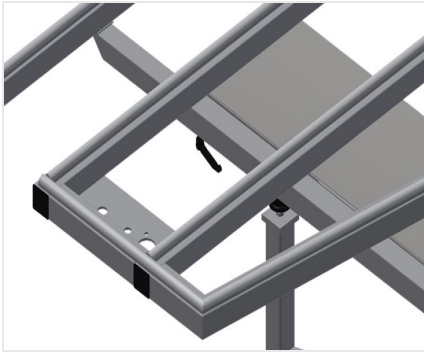

### Pull-out profile support

Pull-out table support at top for KT/KTH 3000 and KT/KTH 4000. The table support can be pulled out 500 mm at the top for high frames



### Brush strip

Supporting surfaces with brush strip



### Felt strip

Supporting surfaces with felt profile strip

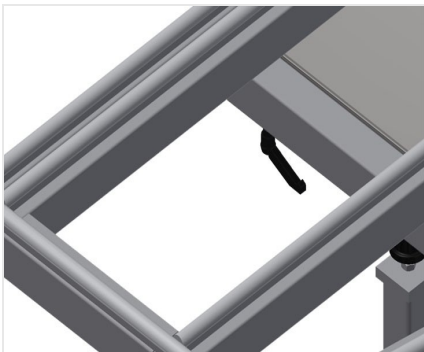

### Rubber strips

Supporting surfaces with rubber-knob profile

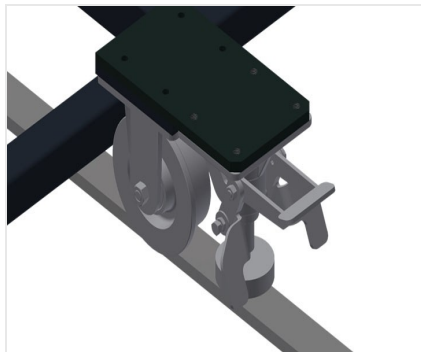

### Mobility unit

Mobility unit for KT/KTH/MS/VE. Mobility unit with flanged rollers and fixing brake

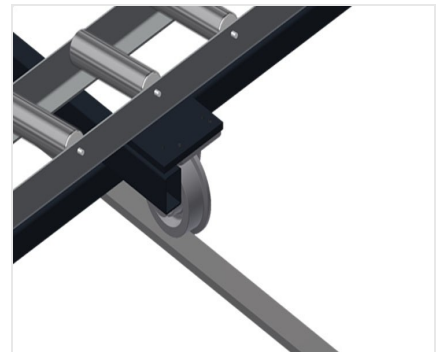

### Rails

Rails, 2.0 m, left and right





### KT 4000 / TILTING TABLES

---

- Length 4,000 mm
- Width 1,820 mm
- Vertical height 1,900 mm
- Roller conveyor width 200 mm
- Weight 350 kg
- Load 200 kg
- Compressed air supply 7 bar
- Air consumption approx. 35 l/min.